



®

**CORPORATION**

# **FLAME ARRESTER**

MODEL 7661

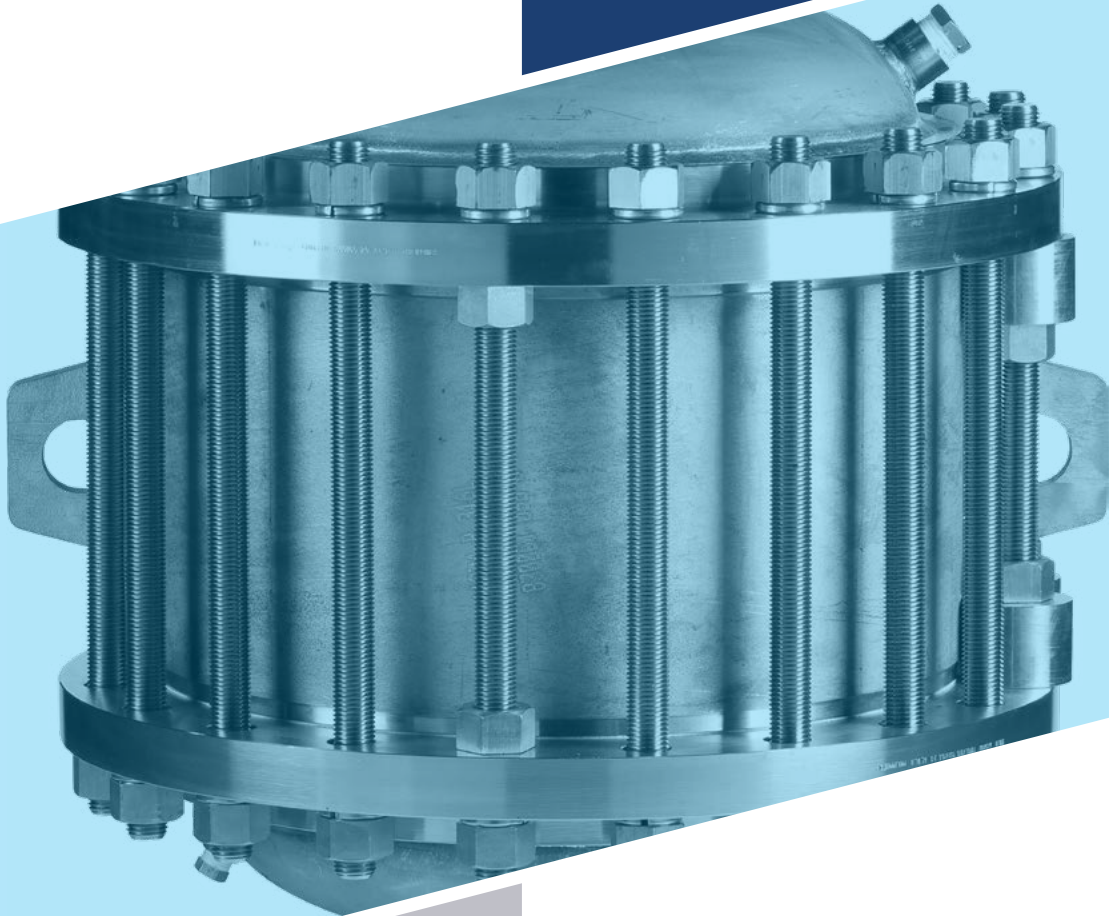

# MODEL 7661

The Groth Model 7661 Deflagration & Detonation Flame Arrester inhibits flame propagation in gas piping systems. The design makes it ideal to protect liquid storage tanks containing NEC Group D (IEC Class IIA).

## Technical Details

- Sizes: 4"x 16" through 12"x 30"
- Housings Materials: Carbon Steel, Stainless Steel, Alloy C276
- Element Materials: Stainless Steel, Alloy C276 or other corrosion resistant alloys
- Unstable detonations
- Pre-ignition system pressure up to 15.7 psia (1.08 bara)
- Pre-ignition system temperatures -4 to 140°F (-20 to 60°C)
- Burn time tBT 20 minutes
- Many sizes certified to ATEX and/or US Coast Guard, please consult factory for information

## Features

- Compact with high flow capacity and low pressure drop
- Elements are easily removed in-line for cleaning and maintenance
- Vertical or horizontal installation
- In-line or end-of-line deflagrations
- Bi-directional with respect to flow and ignition source
- Low pressure drop with multiple element sizes available for each flange size

## Options

- Sensor ports
- Large inspection and cleaning ports
- Swing bolts for fast element removal
- Factory installed thermocouples for flame sensing



# SPECIFICATIONS

Housing Size In (mm)	A Length In (mm)	B Diameter In (mm)	Approx Ship Weight Lbs (kg)
16 (400)	29.63 (753)	23.50 (597)	550 (249)
20 (500)	32.43 (824)	27.50 (699)	850 (386)
24 (600)	38.75 (984)	32.00 (813)	1200 (544)
30 (750)	42.88 (1089)	38.75 (984)	1900 (862)

\* Larger sizes available on special applications.  
All units with ANSI 150 RF flanges standard (other flange drilling available).

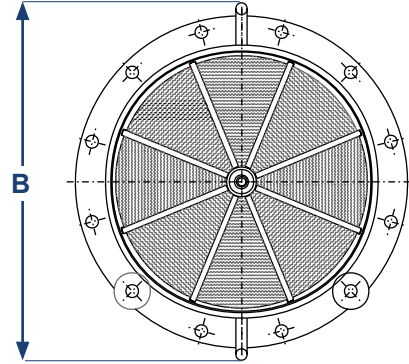
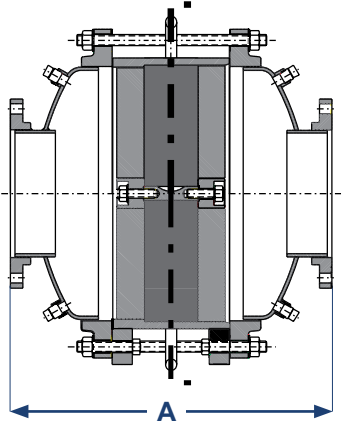

# FLOW CAPACITY

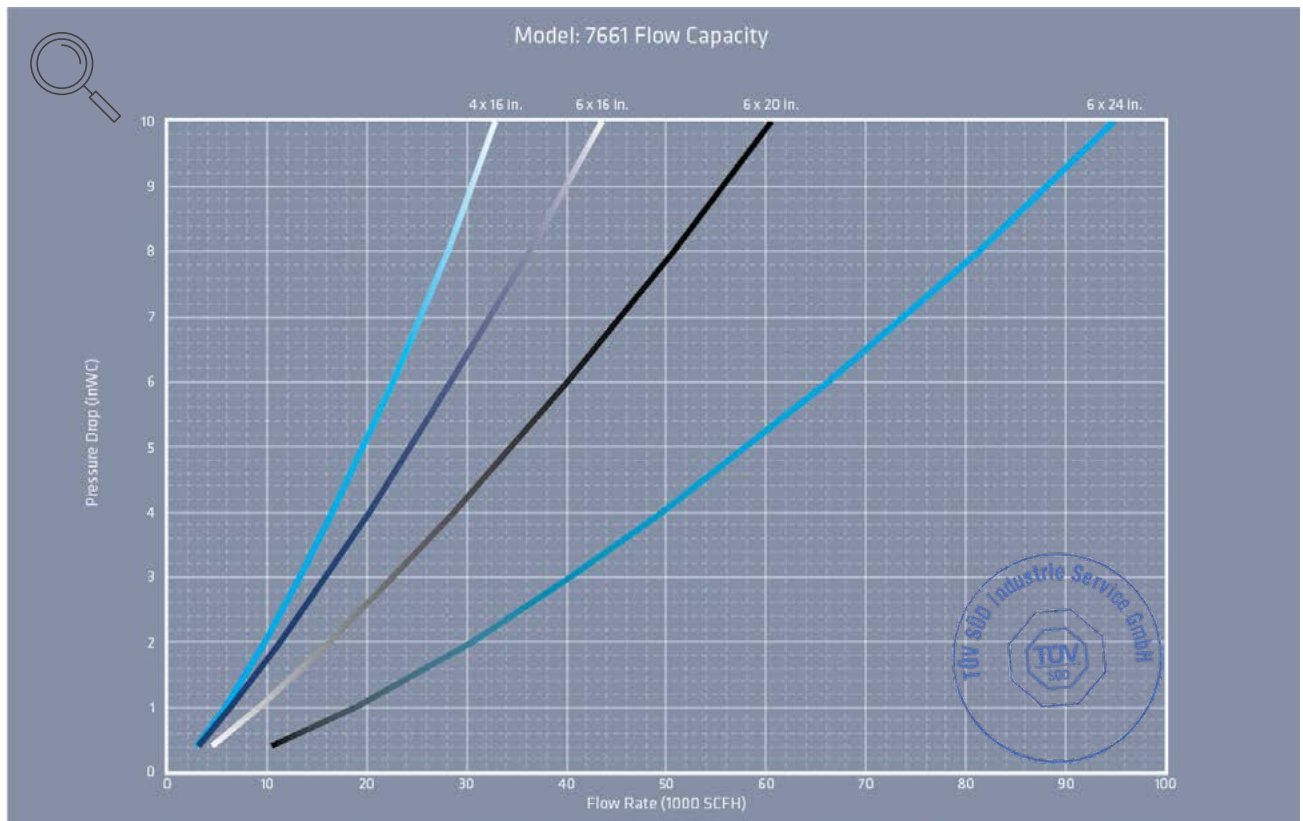
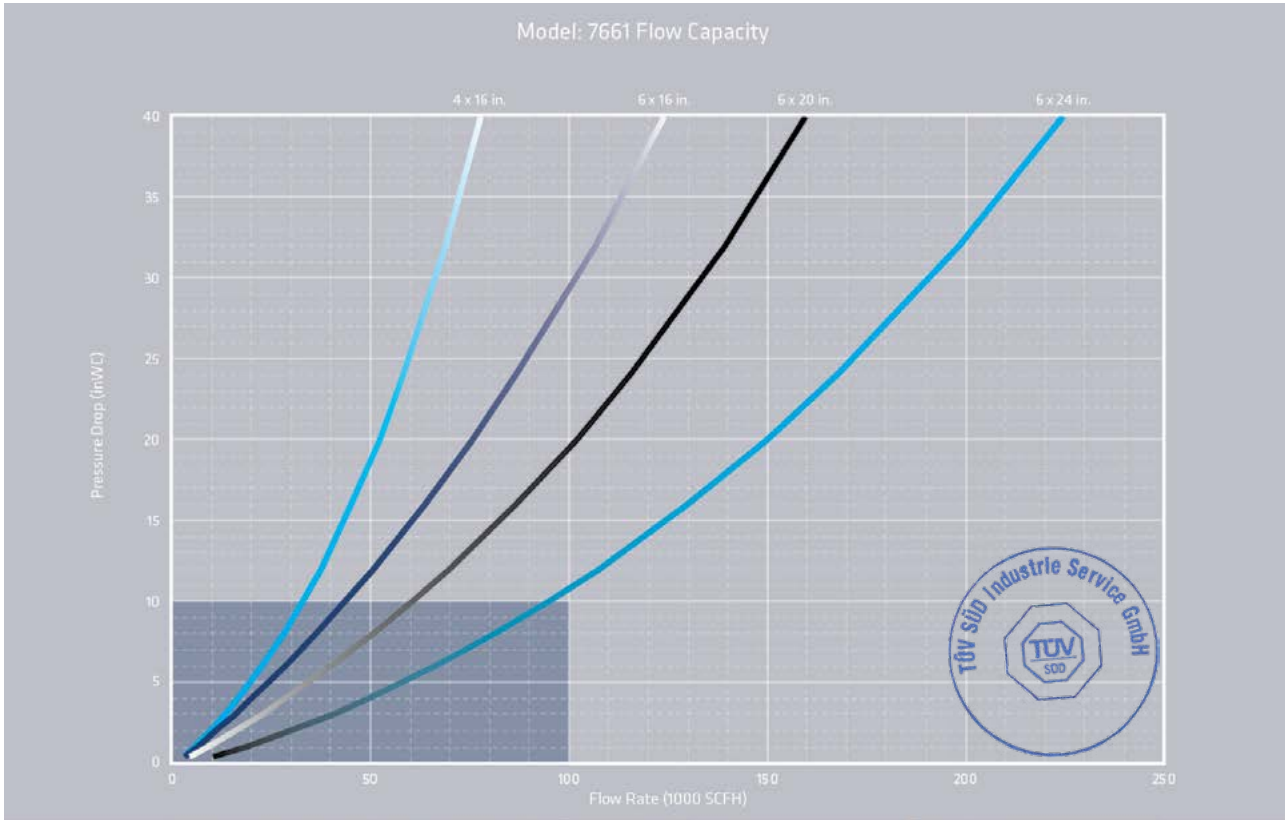

- The test equipment, procedures, and reporting methods utilized by Groth Corporation meet the requirements of standards API 2000/ISO 28300 and ISO 16852. The equipment, methods, and results have been reviewed and certified by TÜV SÜD.
- Flow data are for in-line mounting and does not include entrance losses or exit losses.
- Flow values based on air at 60°F venting to atmospheric pressure of 14.6959 psia



# FLOW CAPACITY

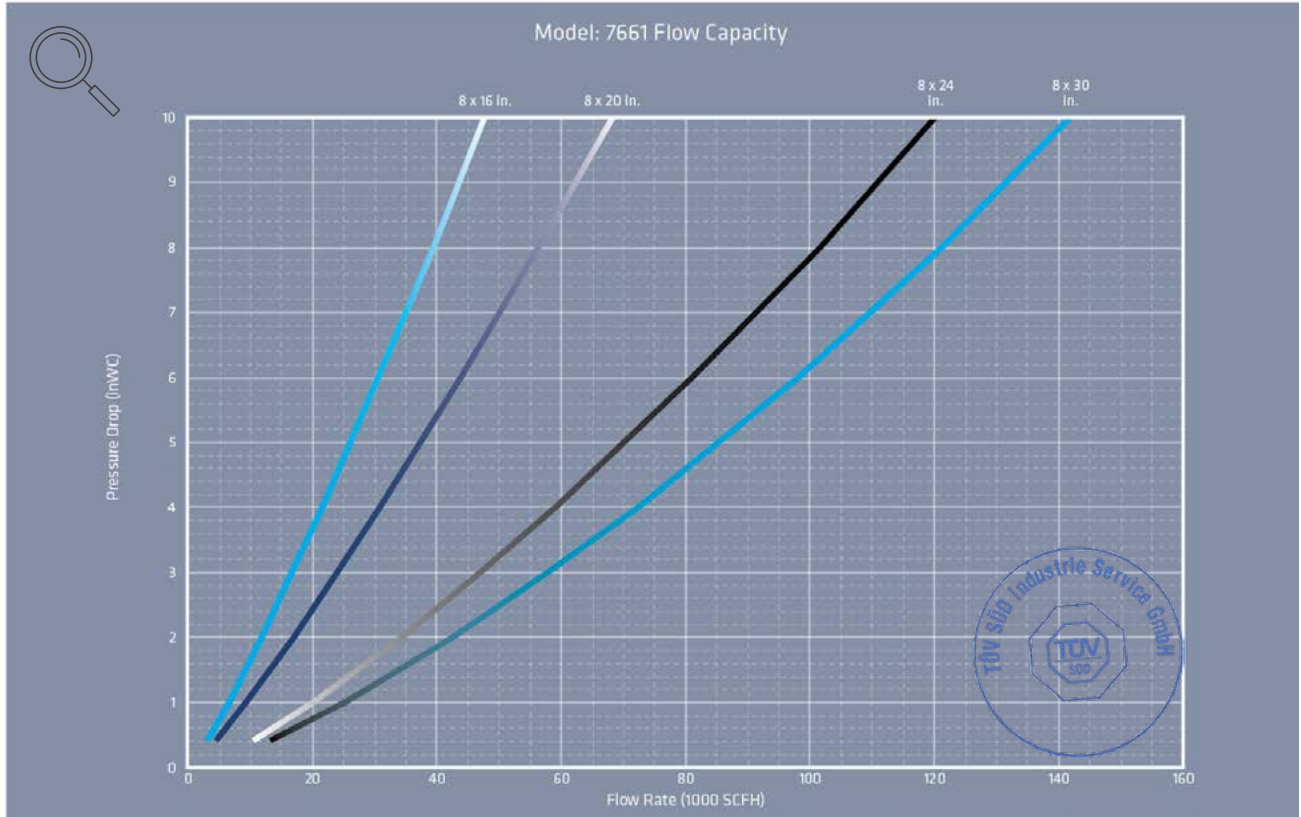
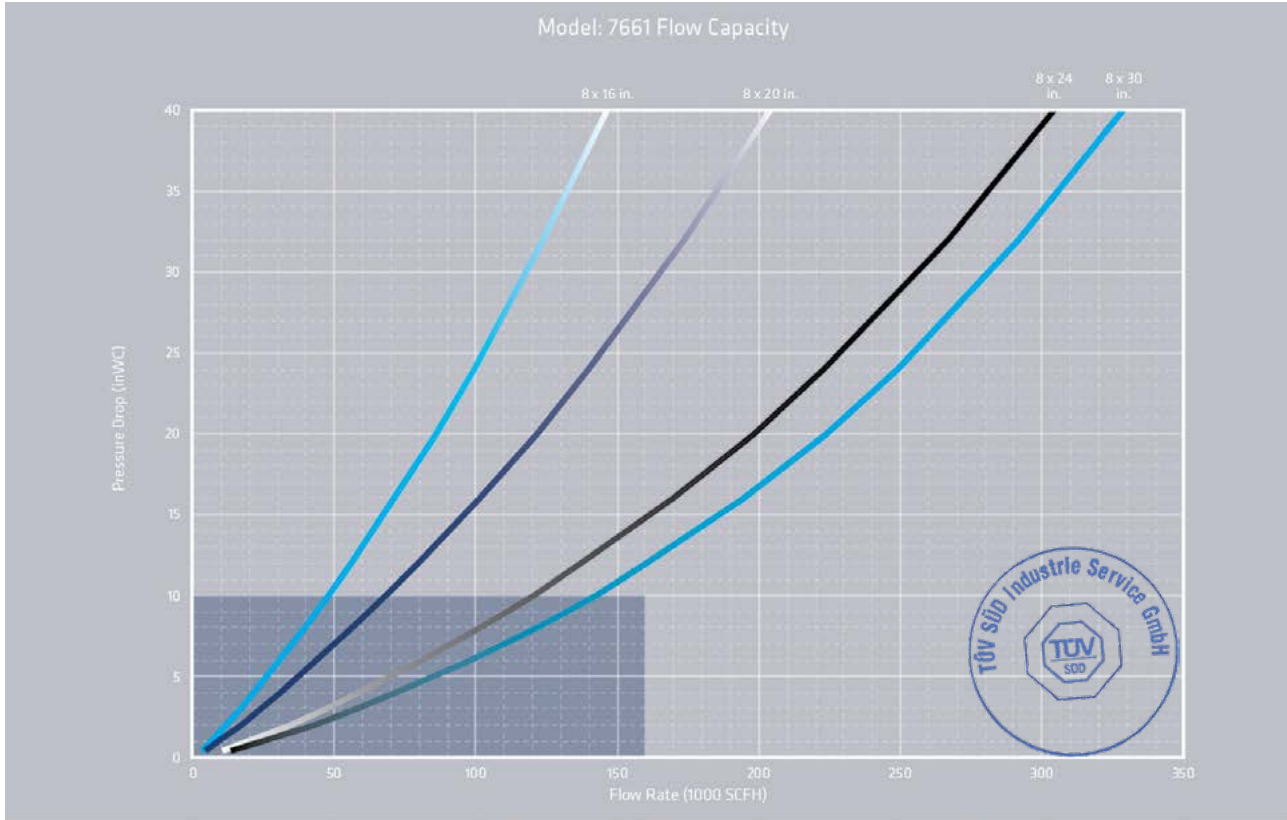

- The test equipment, procedures, and reporting methods utilized by Groth Corporation meet the requirements of standards API 2000/ISO 28300 and ISO 16852. The equipment, methods, and results have been reviewed and certified by TÜV SÜD.
- Flow data are for in-line mounting and does not include entrance losses or exit losses.
- Flow values based on air at 60°F venting to atmospheric pressure of 14.6959 psia

# FLOW CAPACITY

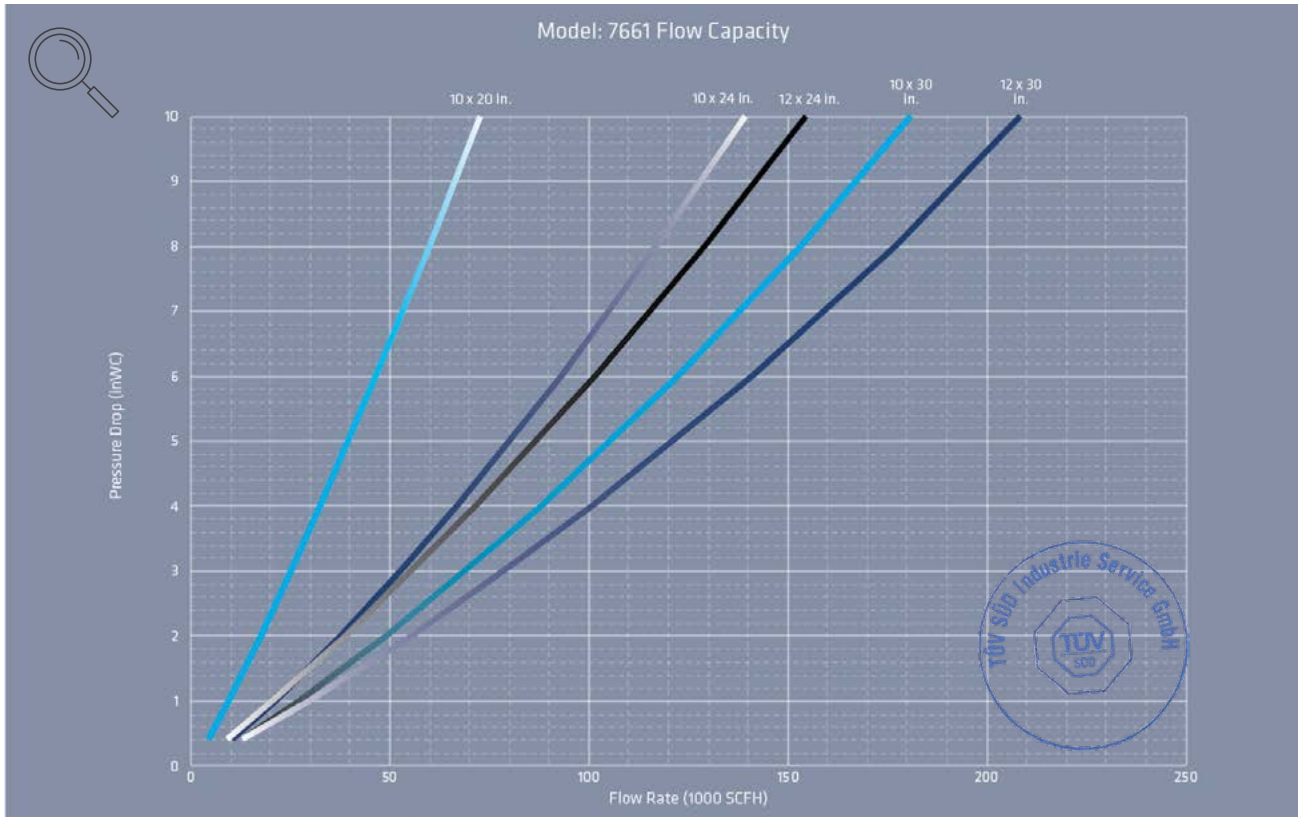
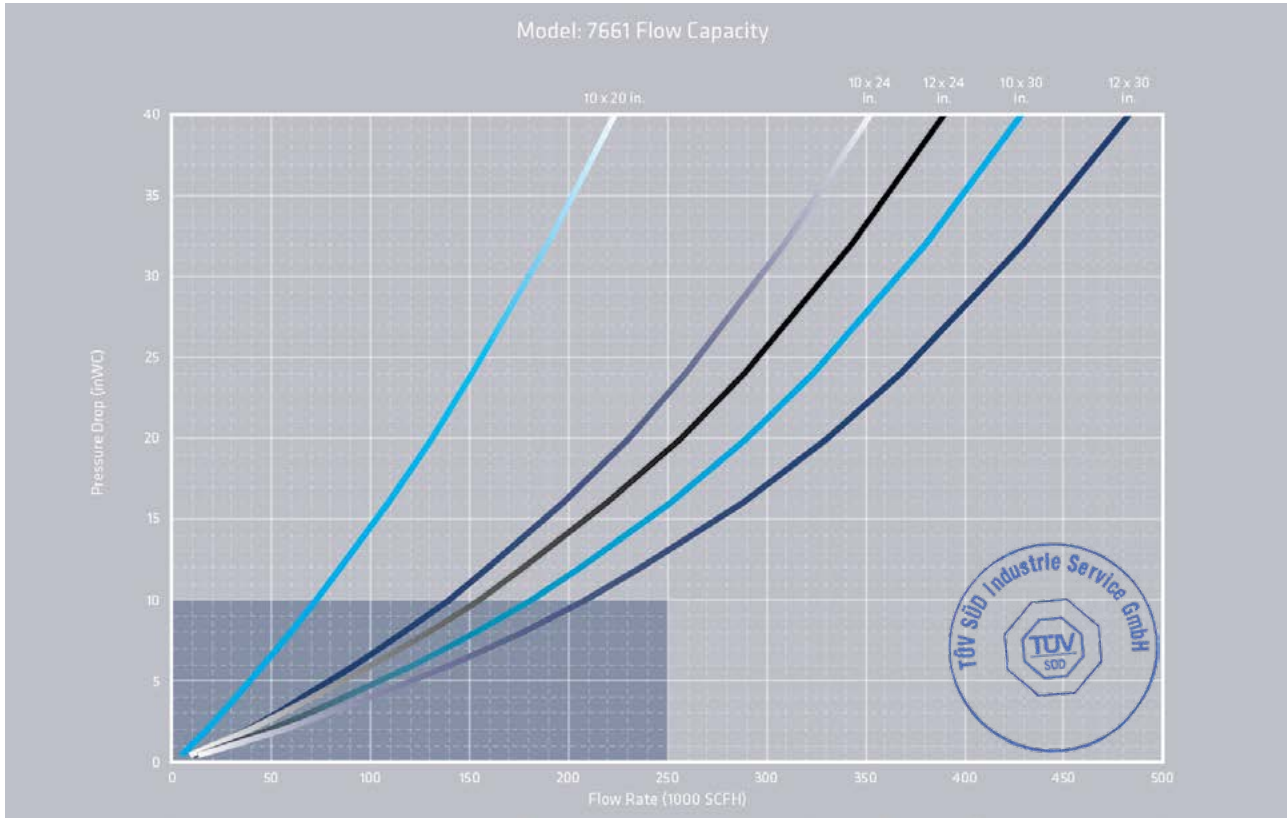

- The test equipment, procedures, and reporting methods utilized by Groth Corporation meet the requirements of standards API 2000/ISO 28300 and ISO 16852. The equipment, methods, and results have been reviewed and certified by TÜV SÜD.
- Flow data are for in-line mounting and does not include entrance losses or exit losses.
- Flow values based on air at 60°F venting to atmospheric pressure of 14.6959 psia

# FLOW CAPACITY

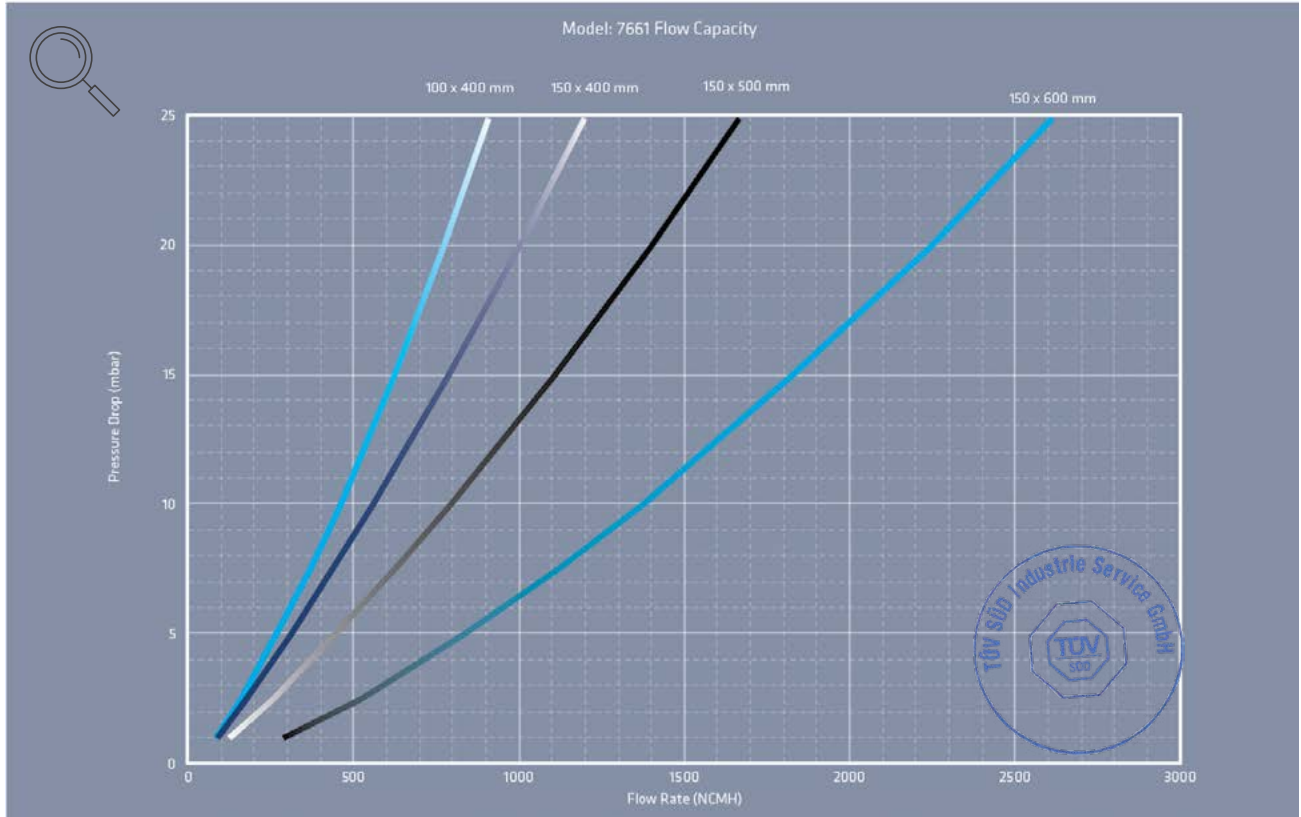
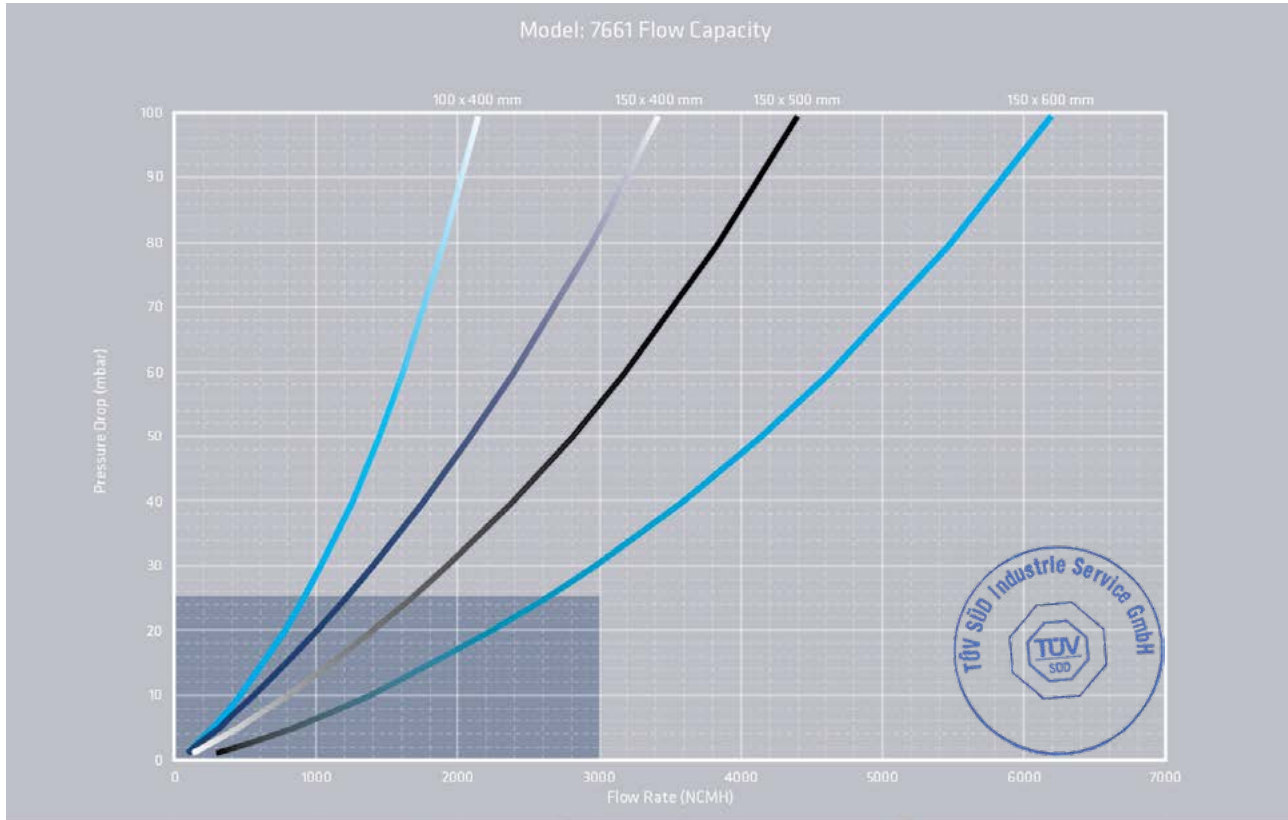

- The test equipment, procedures, and reporting methods utilized by Groth Corporation meet the requirements of standards API 2000/ISO 28300 and ISO 16852. The equipment, methods, and results have been reviewed and certified by TÜV SÜD.
- Flow data are for in-line mounting and does not include entrance losses or exit losses.
- Flow values based on air at 0°C venting to atmospheric pressure of 1.01325 bara



# FLOW CAPACITY

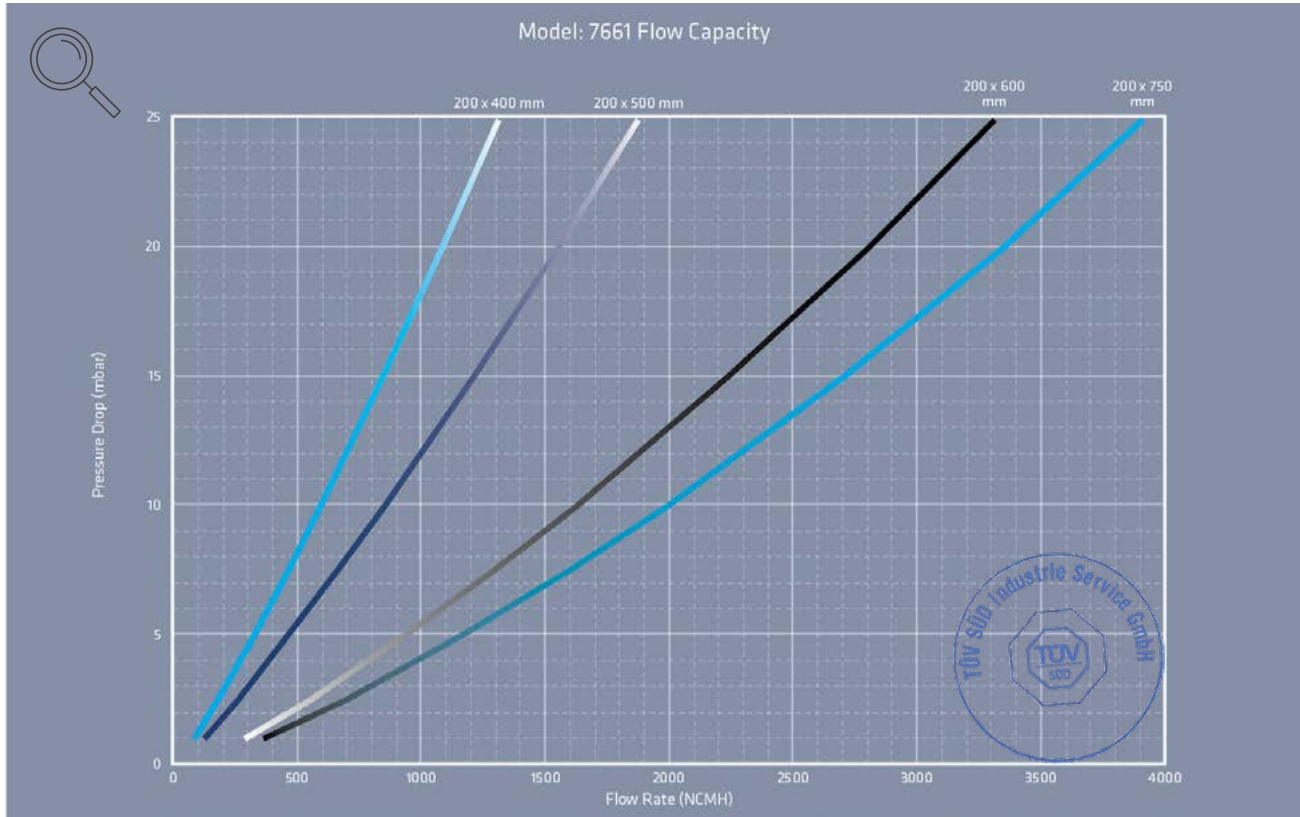
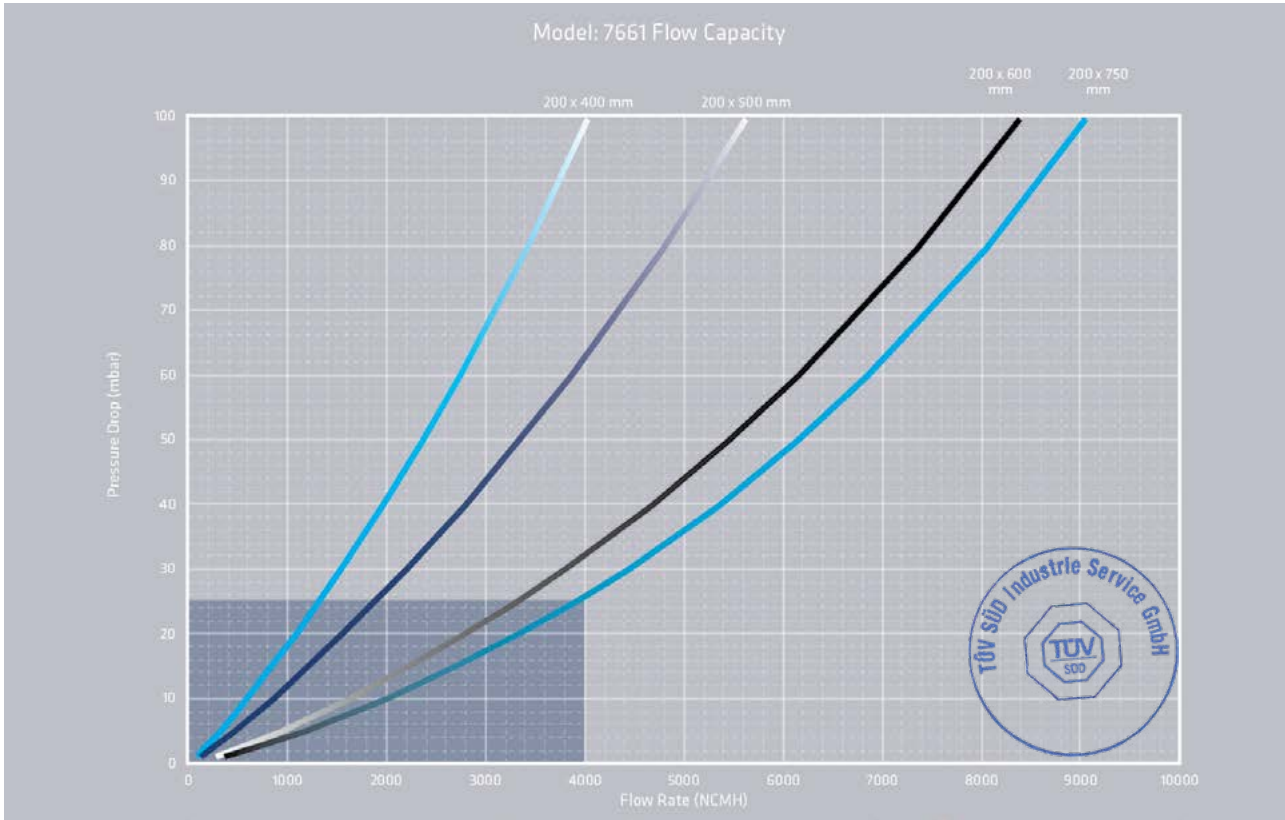

- The test equipment, procedures, and reporting methods utilized by Groth Corporation meet the requirements of standards API 2000/ISO 28300 and ISO 16852. The equipment, methods, and results have been reviewed and certified by TÜV SÜD.
- Flow data are for in-line mounting and does not include entrance losses or exit losses.
- Flow values based on air at 0°C venting to atmospheric pressure of 1.01325 bara



# FLOW CAPACITY

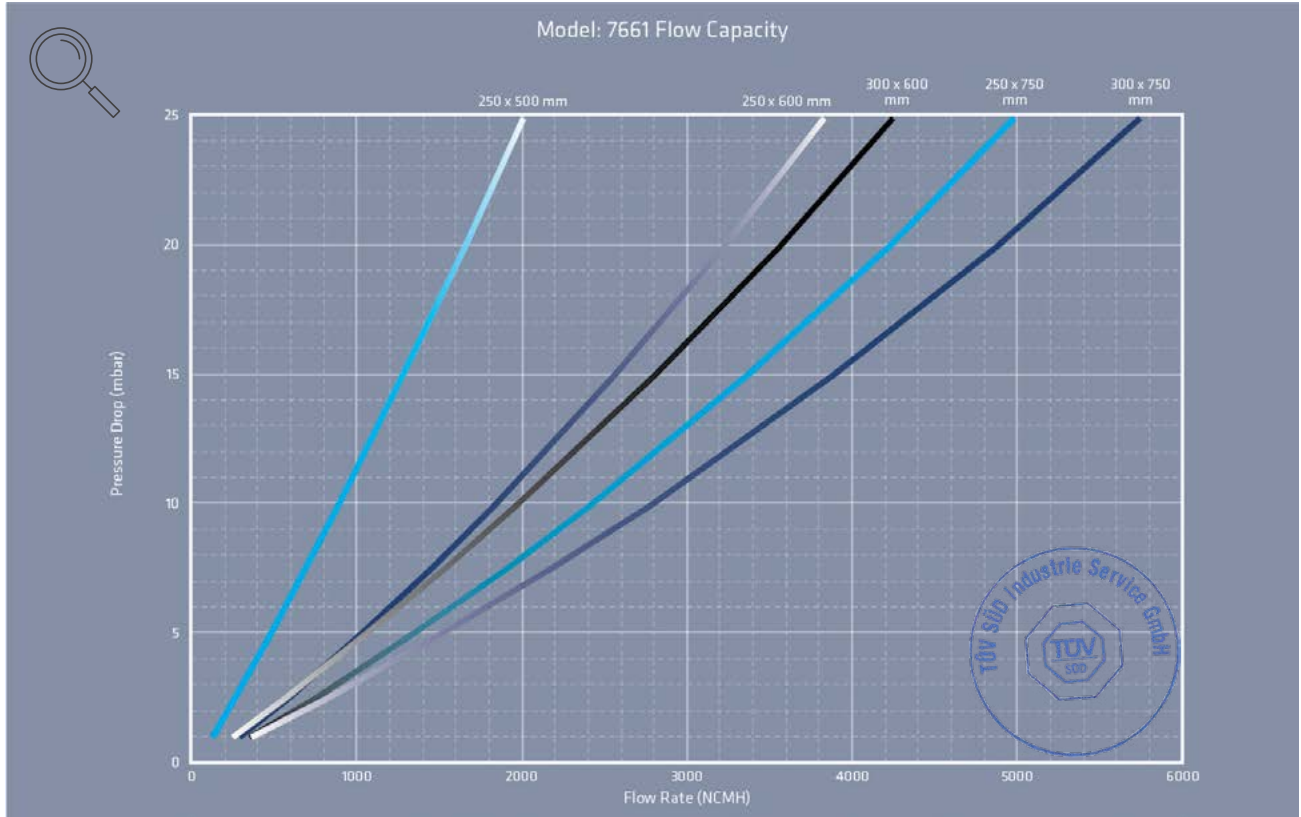
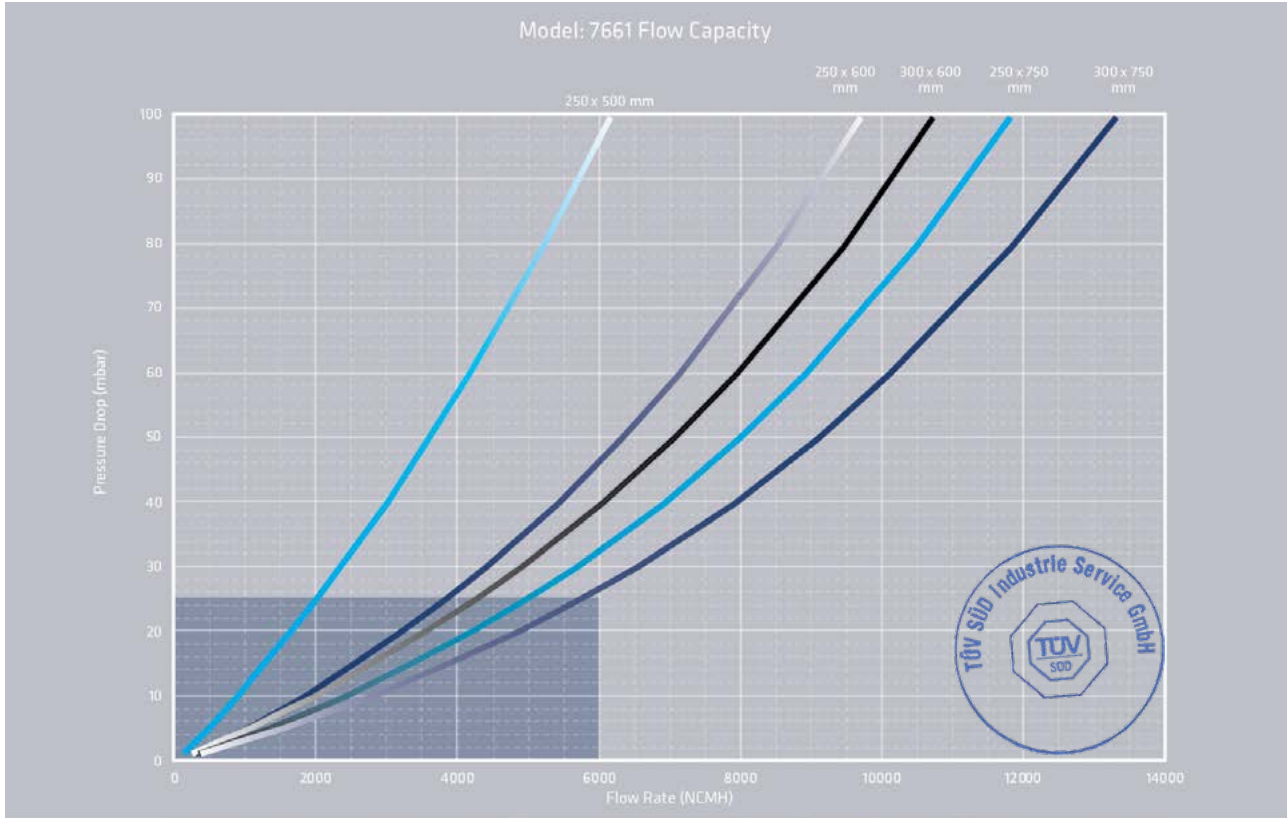

- The test equipment, procedures, and reporting methods utilized by Groth Corporation meet the requirements of standards API 2000/ISO 28300 and ISO 16852. The equipment, methods, and results have been reviewed and certified by TÜV SÜD.
- Flow data are for in-line mounting and does not include entrance losses or exit losses.
- Flow values based on air at 0°C venting to atmospheric pressure of 1.01325 bara

# HOW TO ORDER

For easy ordering, select proper model numbers

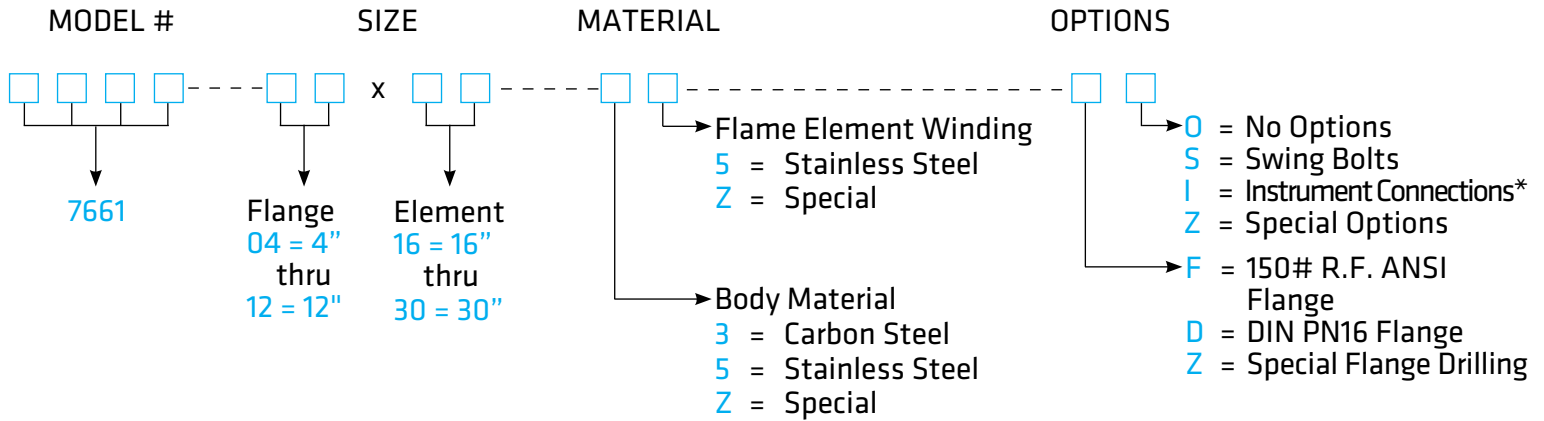

## Notes

- Include model number when ordering.
- For special options, consult factory.
- See flow table for available sizes.
- \* Customer specified size

## Example

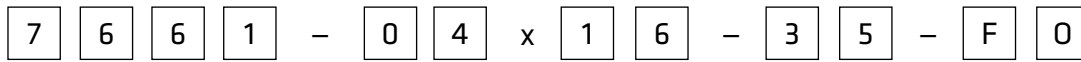

Indicates a 4" Model 7661 with Carbon Steel housing, 16" Stainless Steel Flame Element, ANSI Flanged Outlet and no other options.



®

**CORPORATION**





[GROTHCORP.COM](http://GROTHCORP.COM)